

OPLA' 1530x1920

HOLES FOR RIGHT AND LEFT SIDE

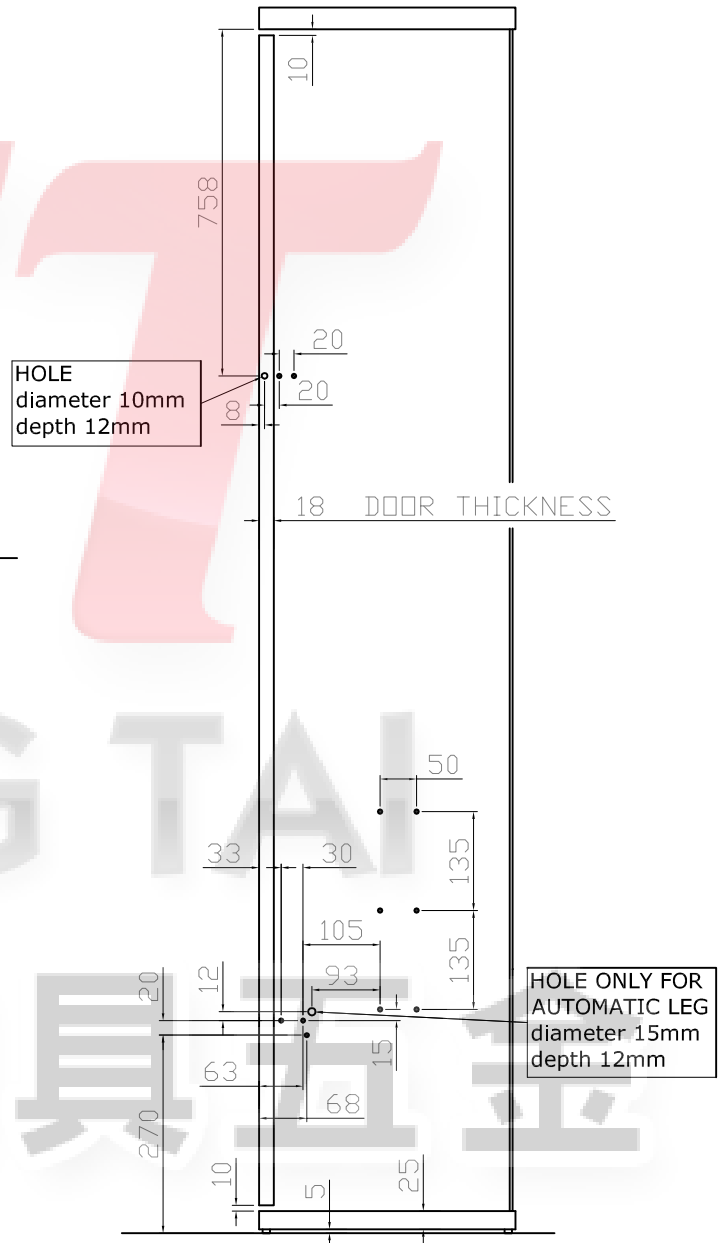
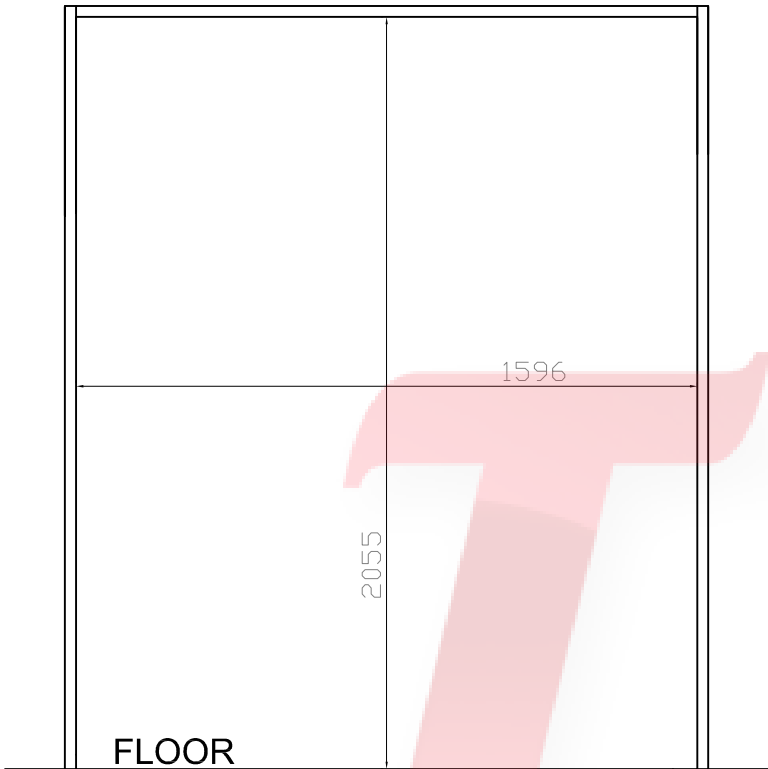

CABINET DIMENSIONS:

INTERNAL WIDE 1596mm
 HEIGHT FROM THE FLOOR 2055mm
 BASAMENT HEIGHT MAX 30mm

EXAMPLE:

BASAMENT HEIGHT 30mm
 DOOR DIMENSION: 1570x2005

METAL BASE DIMENSION: 1530x1920

DEPTH CABINET:

THICKNESS DOOR + 280mm +
THICKNESS BACK PANEL

· THREADED BUSH 6MA

FRONT PANEL + MATTRESS
WEIGHT 75 / 80 Kg
HEIGHT MATTRESS 180mm

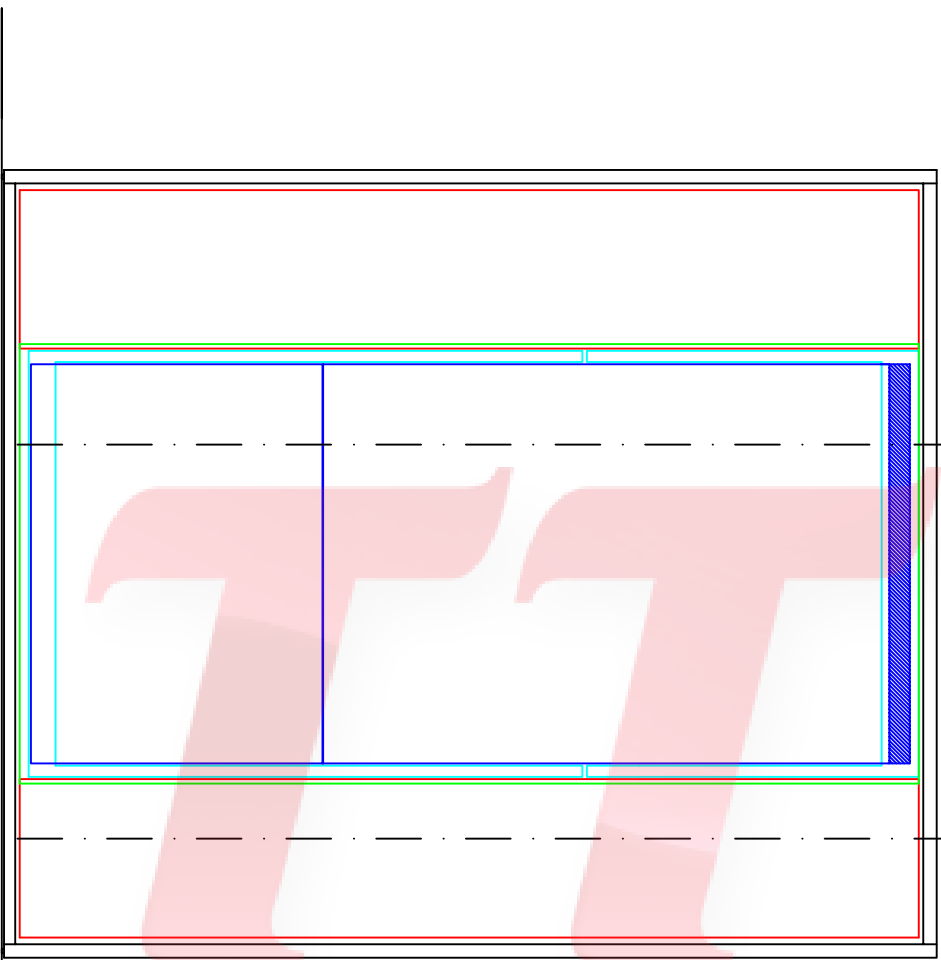

POZZOLI		DATA
CLIENTE	ARTICLO	HOLES OPLA' 1530x1920



-  CABINET
-  METAL BASE
-  DOOR THICKNESS 18MM



A-A

-  DOOR THICKNESS 25MM
-  DOOR THICKNESS 8MM
-  METAL PARTS

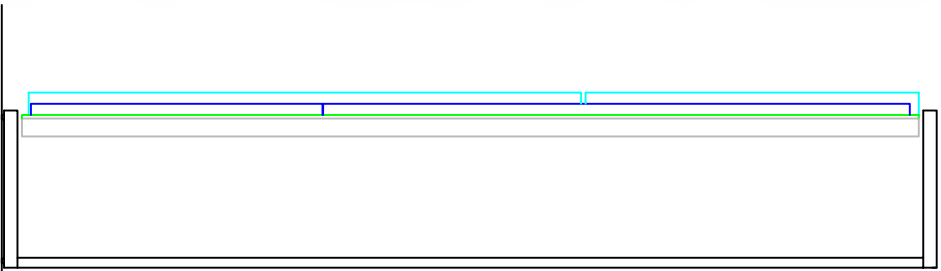

B-B

TENG TAI

騰泰廚具五金

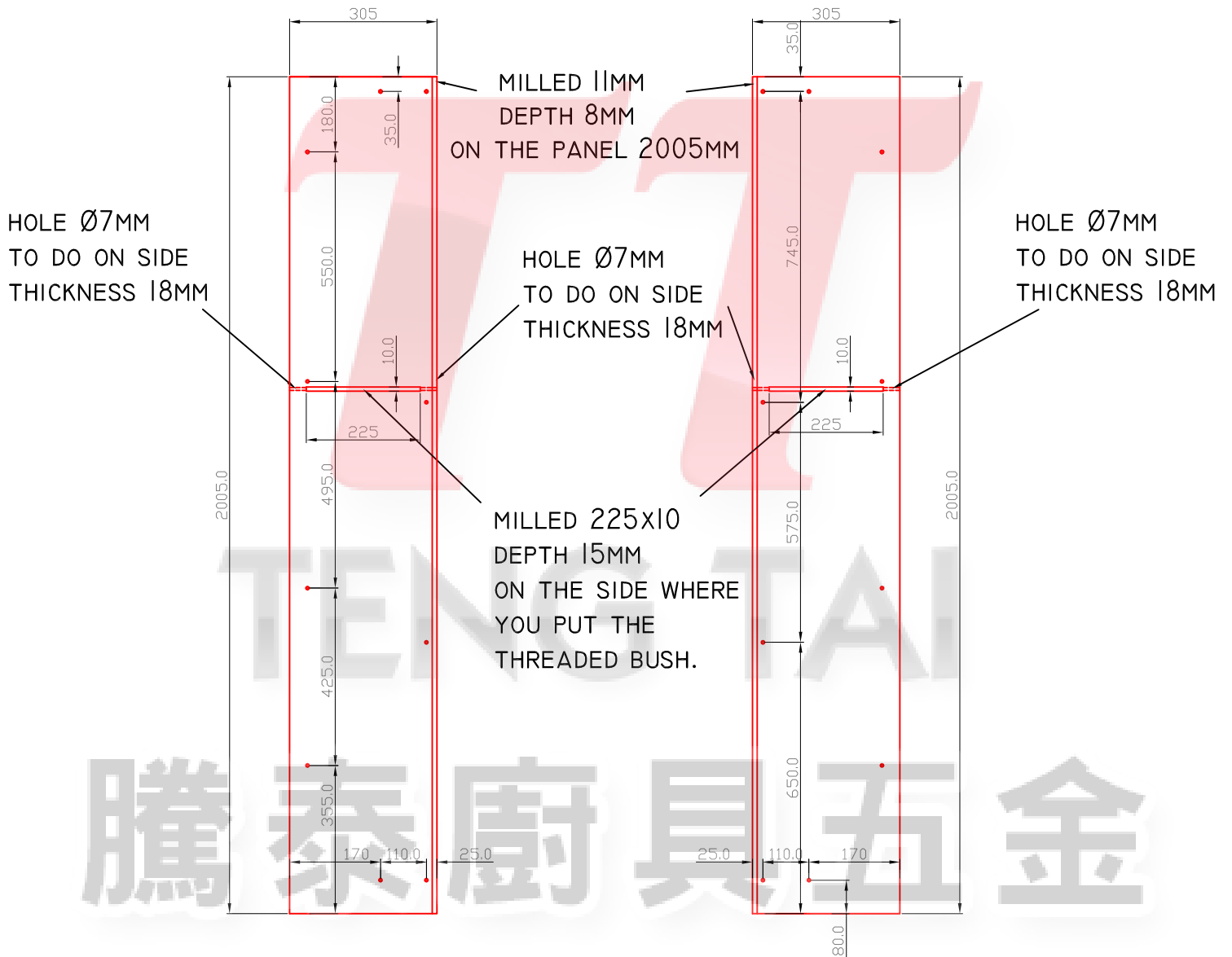
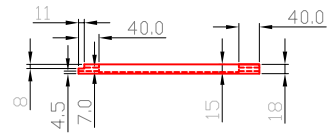
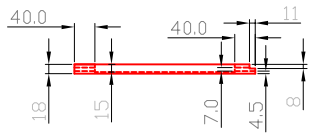

● THREADED BUSH 6MA

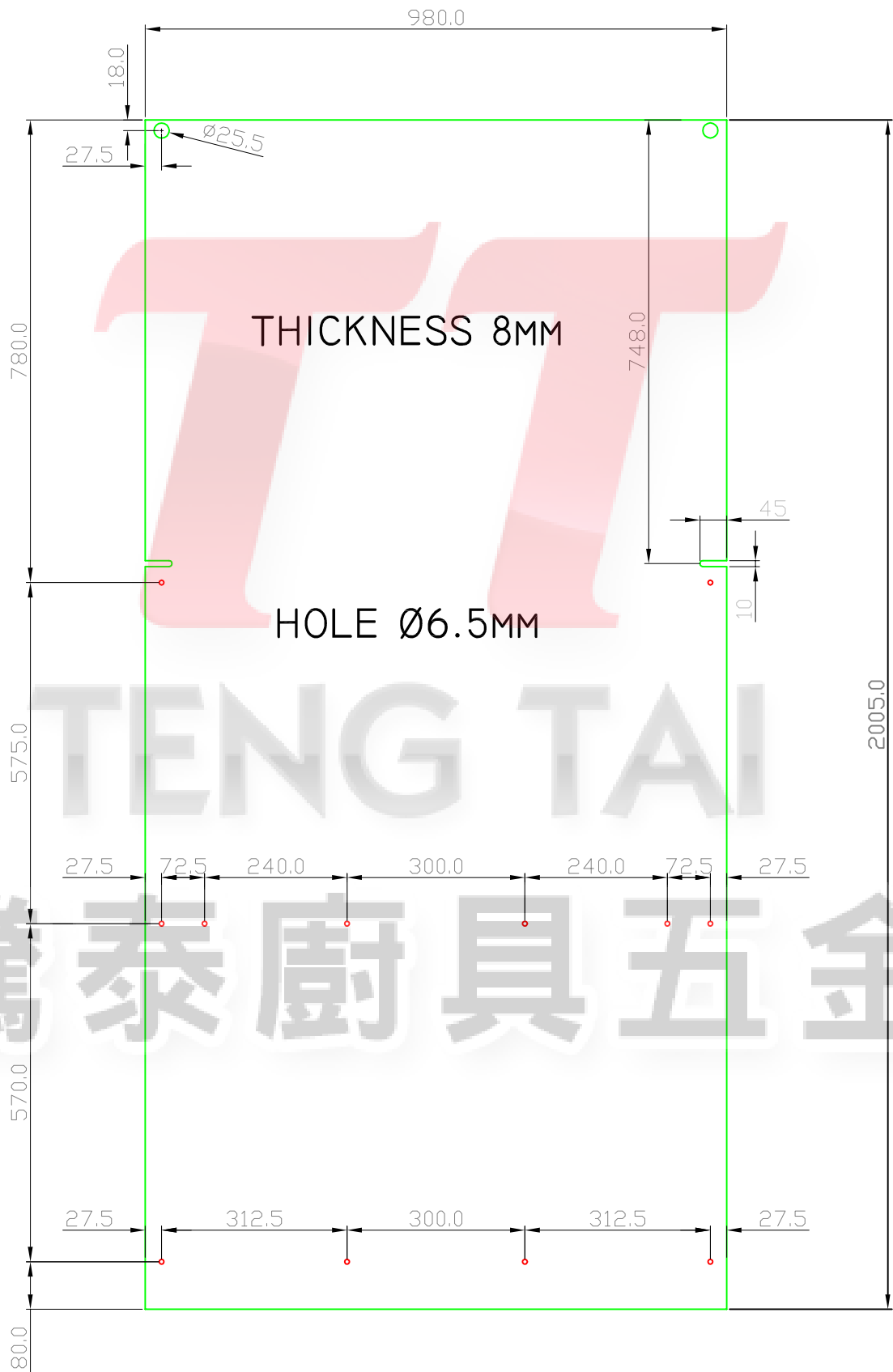

● THREADED BUSH 6MA

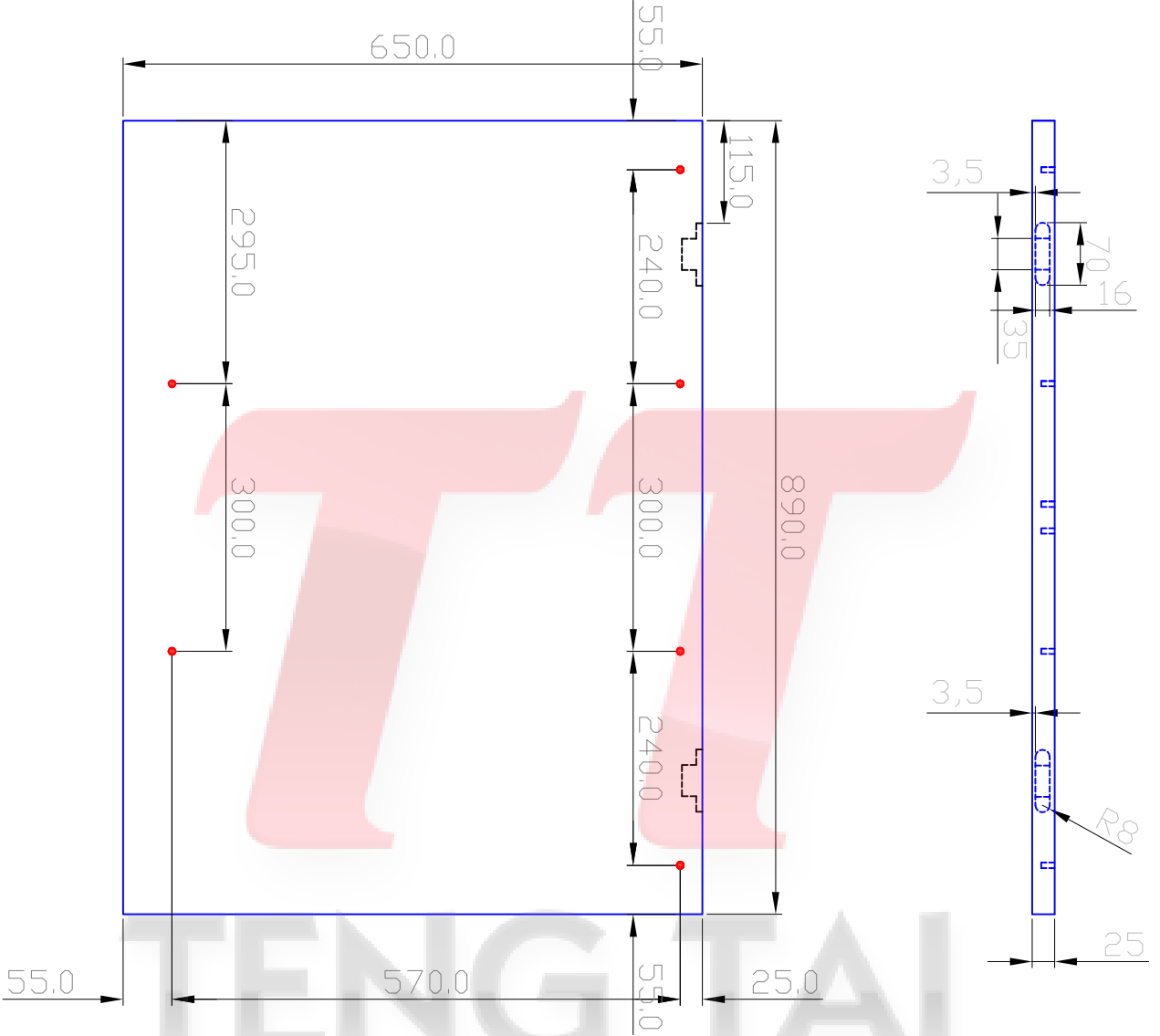

騰泰廚具五金

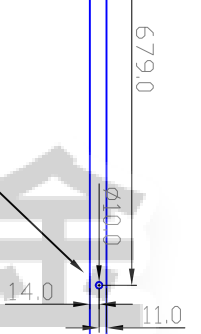
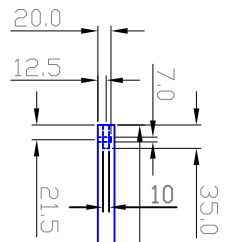
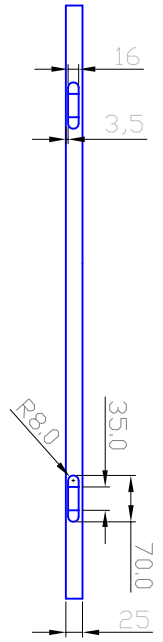
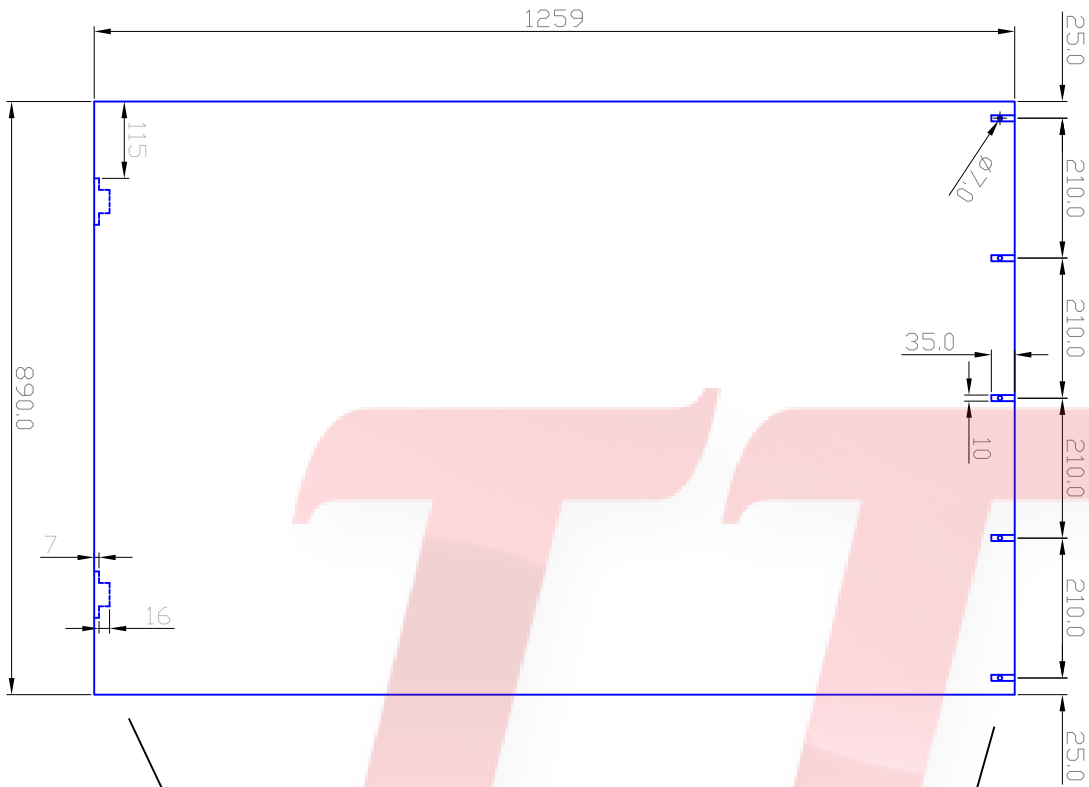

EXTERNAL SIDE WITH TABLE CLOSED

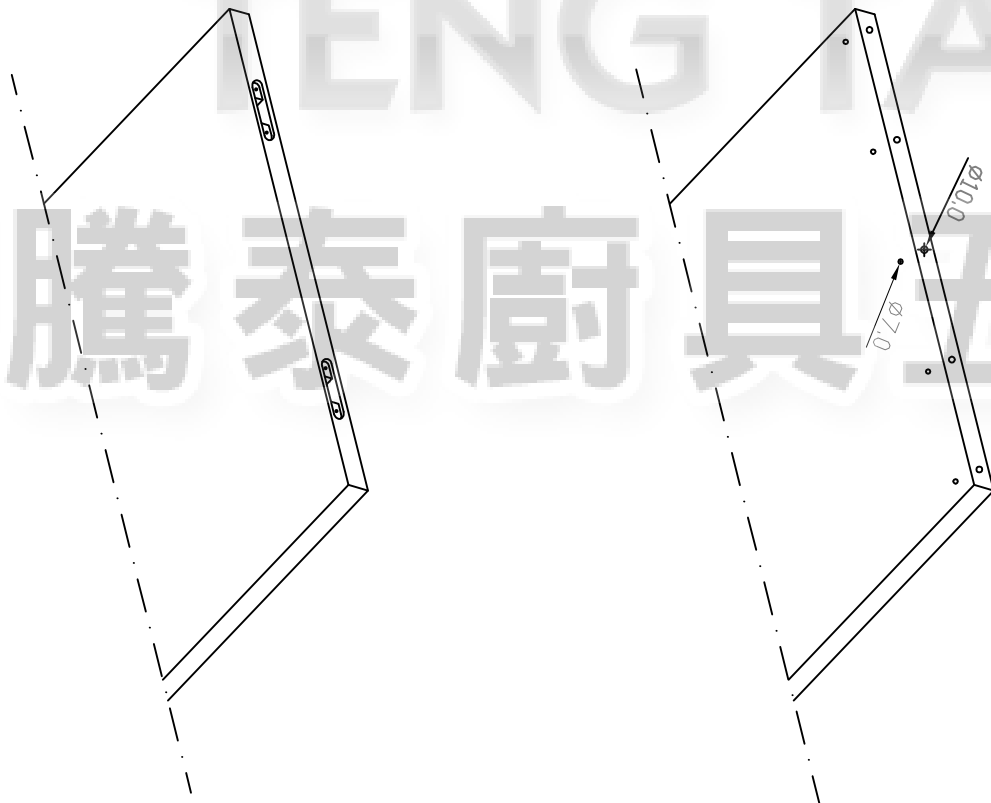
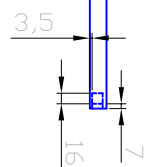

TENG TAI
騰泰廚具五金

POSITION SCREW

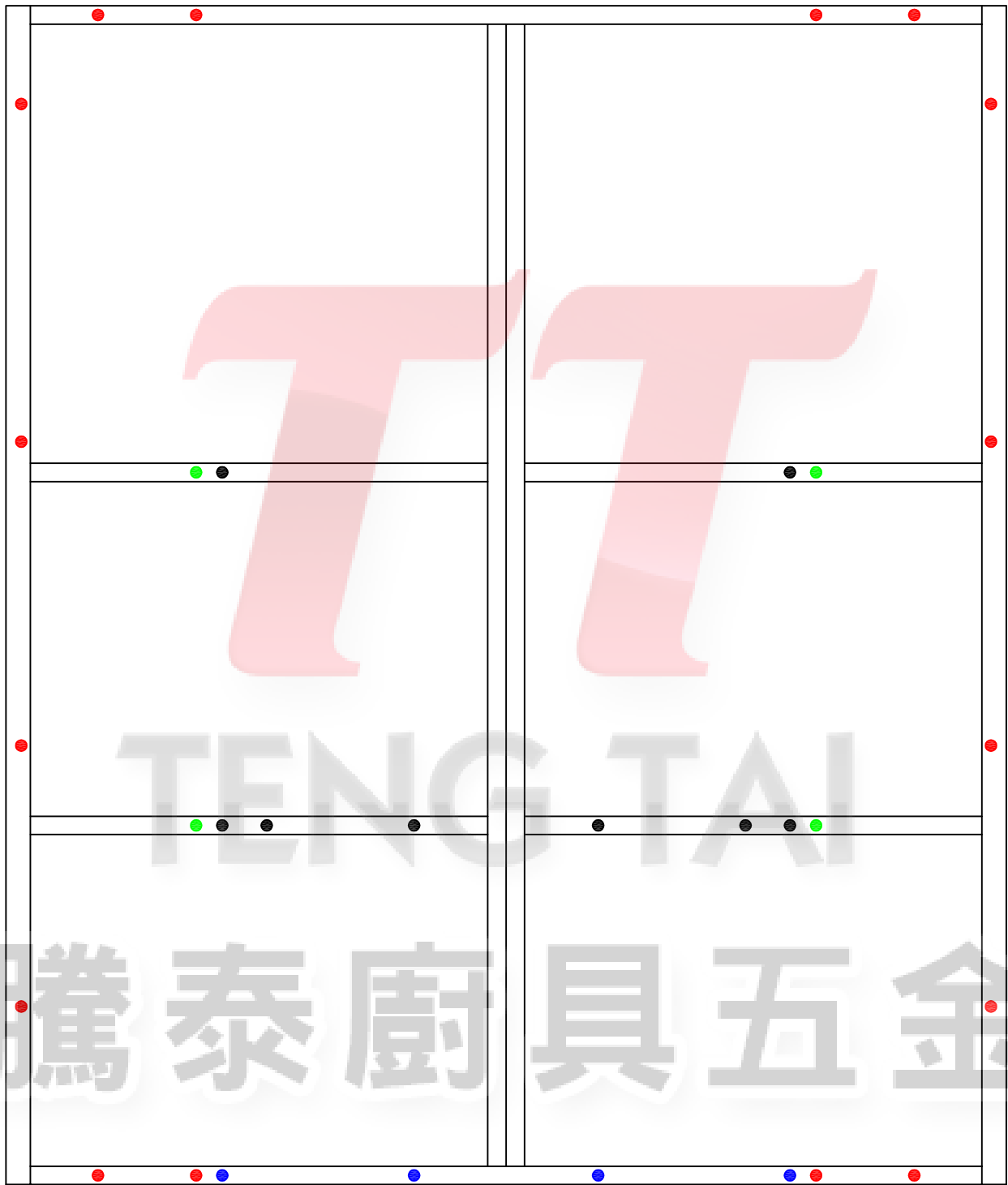

● N.16 SCREW 6x50 TB





● N.4 SCREW 6x25 TB

● N.4 SCREW 6x60 TB

● N.8 SCREW 6x35 TB

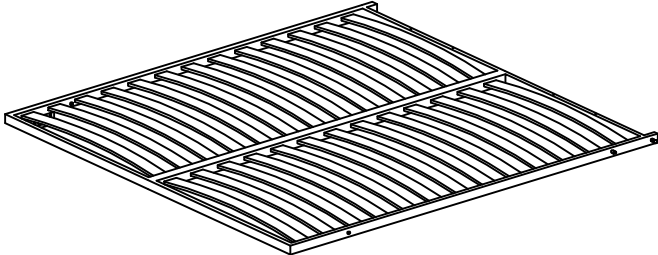
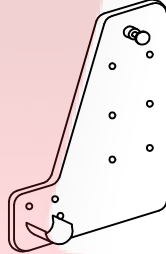

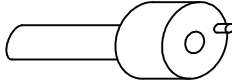
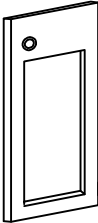
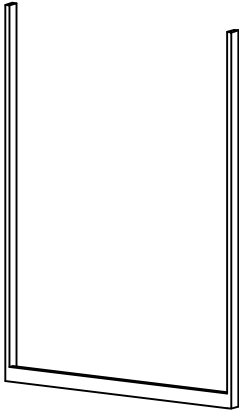
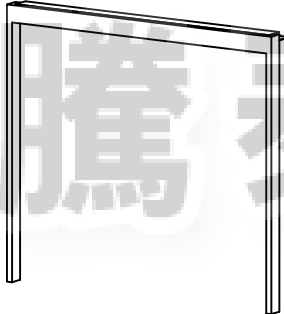
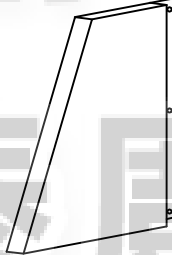
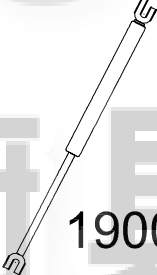
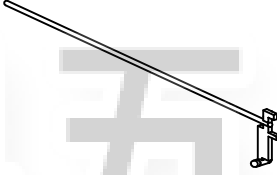
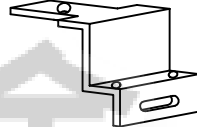
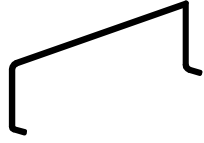
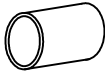
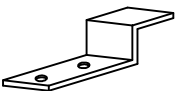
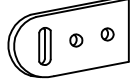



ART. OPLA'

MATERIALE FORNITO - MATERIALS PROVIDED

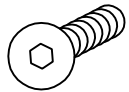
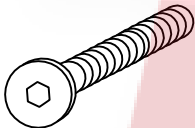
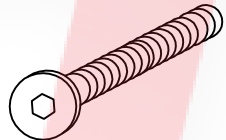
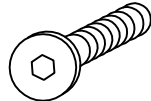
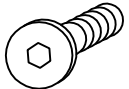
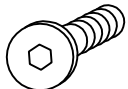
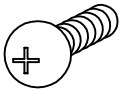
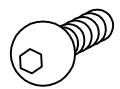
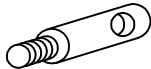
A · 1 x 	B · 2 x 	C · 2 x  metal	D · 2 x 	E · 2 x 		
F · 1 x 	G · 1 x 	H · 2 x 	J · 2 x  1900 N	L · 2 x 	M · 2 x 	N · 2 x 
		O · 2 x  Ø16x25	P · 4 x 	Q · 2 x 	R · 2 x 	

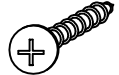
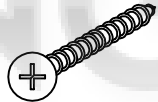
ART. OPLA'

MATERIALE FORNITO - MATERIALS PROVIDED

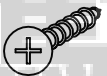
S · 22 x  TPS 6x15	T · 16 x  TP 6x50	U · 4 x  TP 6x60	V · 8 x  TP 6x35	
Z · 4 x  TP 6x25	X · 5 x  TP 6x20	Y · 12 x  TB 6x15	W · 6 x  TB 6x12	K · 5 x 
AA · 3 x  2,5x20	BB · 6 x  TB 4x20	CC · 8 x  4x45	DD · 7 x  magnet	EE · 2 x  6x18 metal
FF · 4 x  6x16 plastic	GG · 4 x  TPS 4x16			